

BMS[®]

Brand Machinery System

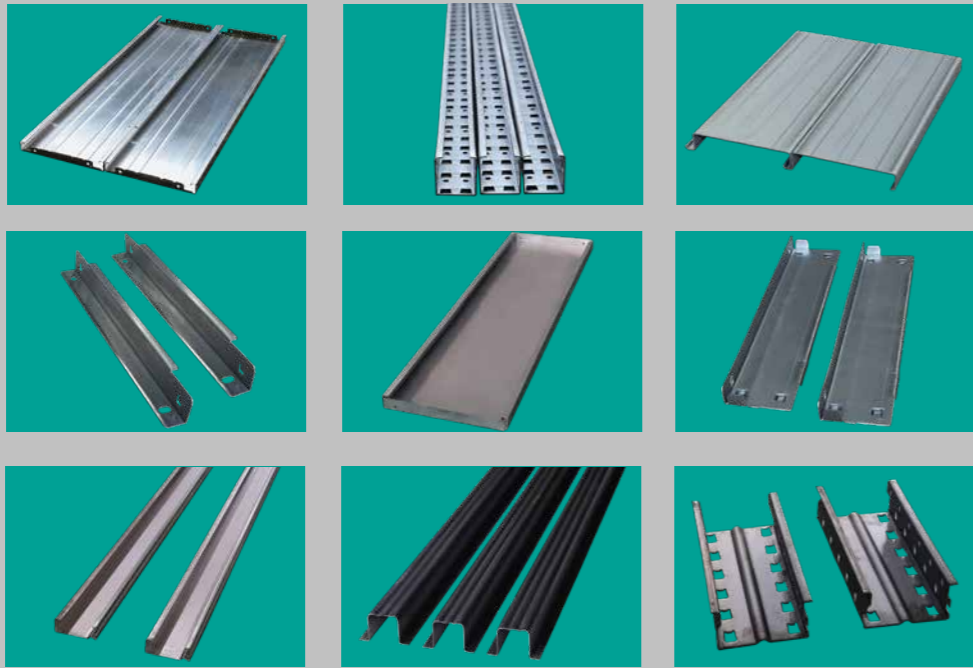

QUALITY IS OUR CULTURE

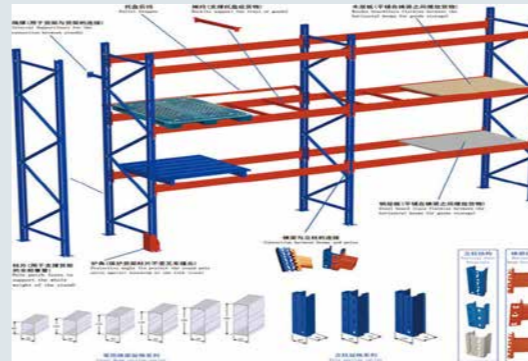

货架系列冷弯成型机手册
Shelving and Racking Series Roll Forming Lines

Brand Forming Machinery Co.,LTD

Contact: Mr Pablo

+86 133 2832 3529

Add:NO.151,Yuehua Road, Huli District, Xiamen City, China.

Tel:0086-592-5616239 Fax:0086-592-5616217

Email:info@rollforming-machinery.com Skype: rollformingmill

WhatsApp/Viber/Line: 008613328323529

Wechat: rollformingmill QQ:2484121

Website: www.rollforming-machinery.com



超20年冷弯机械专业经验，近10年台湾成型机代工经验
Taiwan Quality,China Price.Over 20 Years Rollforming Experience



SGS

CE

TÜV Rheinland[®]

BUREAU VERITAS
1828
VERITAS

公司简介 COMPANY PROFILE

BMS Machinery was initially established in 1992. In 2017, we became a member of ROLL FORM GROUP LTD and invested 4 factories (including Brand Forming Machinery Co., Ltd, Xiamen RY Machinery Co., Ltd, Xiamen Rollforming Machinery Co., Ltd and Xiamen HQ Machinery Co., Ltd), 6 machining centers and 1 steel structure company in China, which totally covers an area of MORE THAN 30000 SQUARE METERS. With over 20 YEARS PROFESSIONAL EXPERIENCE, Our roll forming machines have European CE certification (issued by SGS). We have the honor to serve some of the famous companies in the world such as TATA BLUESCOPE STEEL (Tata Steel and Blue-Scope Steel joint venture), LCP Building Products (a member of LYSAGHT Group of Companies) The Philsteel Group of Companies, Xiamen C&D Group (FORTUNE GLOBAL 500 company), etc.

Shelving and Racking series roll forming machines made by BMS include load beam series, step beam series, box beam series, pallet rack post series, bearing plate series, load beam bracket series. Some series can realize one machine with multiple boards (saving customer equipment investment cost), automatic type change (improving customer production efficiency). Following the development trend of intelligent storage, BMS developed the roll forming machines for AGV and RGV automated three-dimensional warehouse shelving and racking system. We can also customize according to customer requirements or drawings. One-stop roll forming solution to serve the material handling industry.

We have great confidence in the quality and precision of our cold roll forming machines. We know well the particular requirements for the customers of different countries and regions. Our main technology comes from Taiwan, but with China price. Our cold roll forming machines have been exported to more than 60 countries and regions, including South Korea, Taiwan, UK, France, Ireland, Greece, Australia, USA, Mexico, Brazil, Chile, Israel, Russia Saudi Arabia, UAE, India, Singapore, Malaysia, Thailand, Indonesia, Philippines, Vietnam, South Africa Nigeria, Egypt, etc. WITH US YOUR MONEY IN SAFE YOUR BUSINESS IN SAFE.

贝姆斯【英文名称: BRAND FORMING MACHINERY CO., LTD .简称: BMS】前身源自成立于1992年的华粤机械厂龙海公司。2009年与日本TOKYO DENKI在香港成立东京电机控股有限公司, 主营金属成型工业品设计与冷弯机械配件检测。2015年成立海外营销公司-厦门贝姆斯建筑科技有限公司。2017年公司加入北美ROLL FORM GROUP LTD集团, 投资4家生产工厂(包括: 厦门众志隆机械设备有限公司、厦门瑞孚机械有限公司、厦门容益机械有限公司、厦门虹庆机械有限公司), 6家机加工中心, 1家钢结构公司。工厂总占地面积30000多平方米, 从业及相关配套人员达200多人, 为客户提供新开厂的 整厂解决方案 (工厂布局, 机械设计、制造、安装与培训服务)。

凭借超过20年的冷弯机械专业经验与近10年台湾成型机代工经验, 公司形成了以台湾机器质量为企业文化。在行业内首创品质部独立于生产部的管理模式, 解决了冷弯行业内的品检弊病。我们的机器已获得瑞士SGS检验集团签发的欧盟CE认证。我们很荣幸为国内及世界上一些著名的钢铁与钢结构公司提供服务, 如中建, 中铝瑞闽股份, 中石集团, 建发集团, 冀东水泥, 华胤钢构(台资企业), 新蓝天钢结构, 福建树人活动房集团, 福建省工业设备安装公司(福建建工集团下属), 广东金诚鹏集团, 浙江普天集成房屋, 印度Tata Bluescope Steel(印度最大的TATA集团下属公司), 新加坡LCP Building Products(LYSAGHT集团公司成员), 韩国KSI(三星集团项目供应商), PhilSteel(菲律宾钢铁控股公司)等。

贝姆斯(BMS)生产的货架系列成型机包括横梁系列, 步进梁系列, 立柱系列, 承板系列, L型连接板, 斜撑系列与支架系列等。部分系列可以实现一机多板(节约客户设备投资成本), 自动换型(提高客户生产效率)。贝姆斯(BMS)紧跟智能仓储的发展趋势, 开发出AGV与RGV自动化立体仓库配套的货架成型机。我们还可根据客户要求或者图纸定制。

贝姆斯(BMS)对机器的质量和精度充满信心。我们遵循台湾机器质量标准, 建立了自己的测试实验室, 测试设备包括洛氏硬度计, 转速计, 圆度测量仪, 涂层测厚仪和 多功能试验机。我们的主要技术来自台湾, 并提供有竞争力的机器价格。BMS冷弯成型机不仅具有性价比高的设备, 而且技术不断创新。客户机器订单从生产到售后由同一组技师团队完成, 以保证机器在客户现场可以最短时间进入高效生产状态, 并提供7天X24小时技术支持和工程师海外服务。通过公司的不断努力和发 展, 公司在国内外赢得了优秀的信誉和良好的口碑, 并已出口到世界60多个国家和地区, 包括韩国, 台湾, 英国, 澳大利亚, 美国, 加拿大, 墨西哥, 俄罗斯, 沙特阿拉伯, 阿联酋, 新加坡, 马来西亚, 泰国, 印度尼西亚, 菲律宾, 越南, 南非, 埃及等。贝姆斯(BMS)的使命是做全球信赖的冷弯机械专业制造商与服务商, 为客户提供赚钱的机器, 为您的金属板材增加价值。台湾品质, 高效生产, 一台顶俩。

国内外客户 Domestic and foreign customers



澳大利亚客户
Australian Customer



英国客户
UK Customer

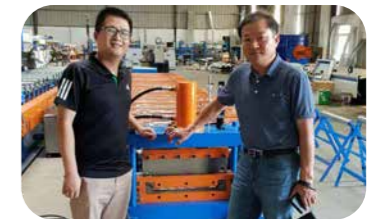

秘鲁客户
Peruvian Customer



希腊客户
Greek Customer



韩国客户
Korean Customer

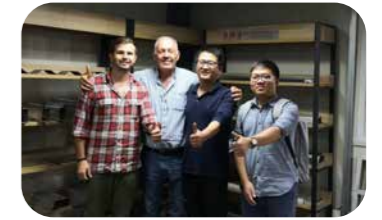

葡萄牙客户
Portugal Customer

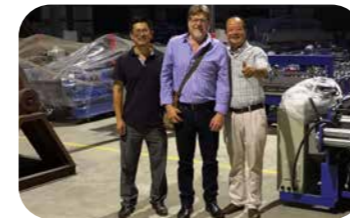

奥地利客户
Austrian Customer



墨西哥客户
Mexican Customer

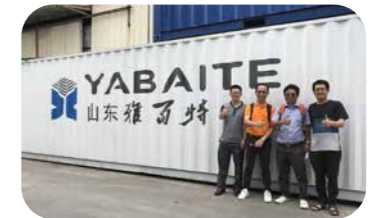

山东客户
Customer in Shandong



印度客户
Indian Customer



菲律宾客户
Philippines Customer



美国客户
US Customer

荣誉证书 HONOR CERTIFICATE



货架立柱（仓储）成型机

Pallet Rack Post Roll Forming Machine-Warehouse series

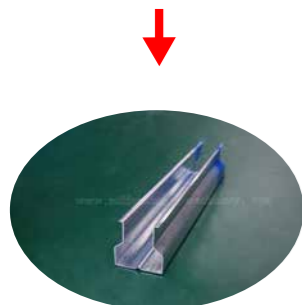

样品图
Sample

▶▶▶▶▶ 版型图
Profile Drawing

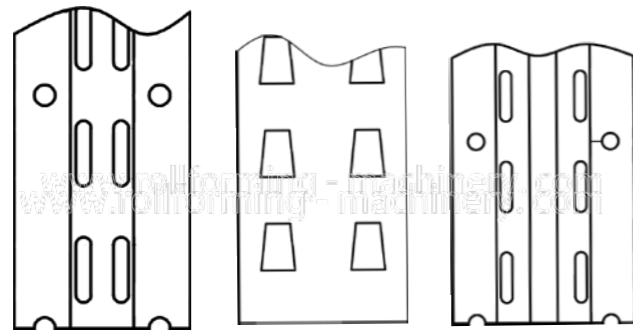

样品图
Sample

成型后剪
Cut after forming

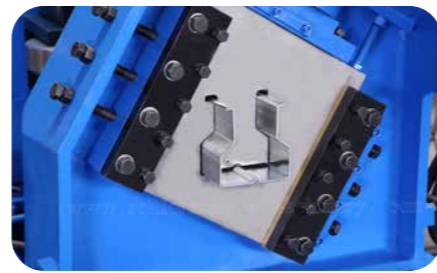

▶▶▶▶▶ 工艺流程图
Producing Process Sketch



设备参数 (MAIN PARAMETERS)

▶ 货架立柱（仓储）成型机	▶ Pallet Rack Post Roll Forming Machine-Warehouse series
▶ 辊压厚度：2.0-3.0mm	▶ Thickness：2.0-3.0mm
▶ 验机厚度：2.5mm	▶ Inspection Thickness：2.5mm
▶ 辊压材料：G340-G550镀锌板、冷轧板	▶ Galvanized Steel Coils：G340-G550
▶ 进料宽度：310mm	▶ Feeding Width：310mm

货架立柱（仓储）成型机

Pallet Rack Post Roll Forming Machine-Warehouse series



样品图
Sample



成型后剪
Cut after forming

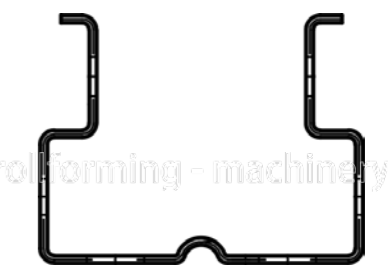

版型图
Profile Drawing

▶▶▶▶▶ 工艺流程图
Producing Process Sketch



货架立柱（超市）成型机

Pallet Rack Post Roll Forming Machine-Supermarket series



样品图
Sample



▶▶▶ 版型图
Profile Drawing

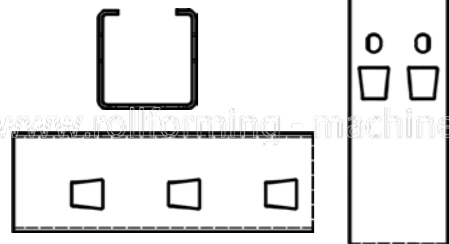

▶▶▶ 工艺流程图
Producing Process Sketch



货架承板（仓储）成型机

Deck Panel Roll Forming Machine

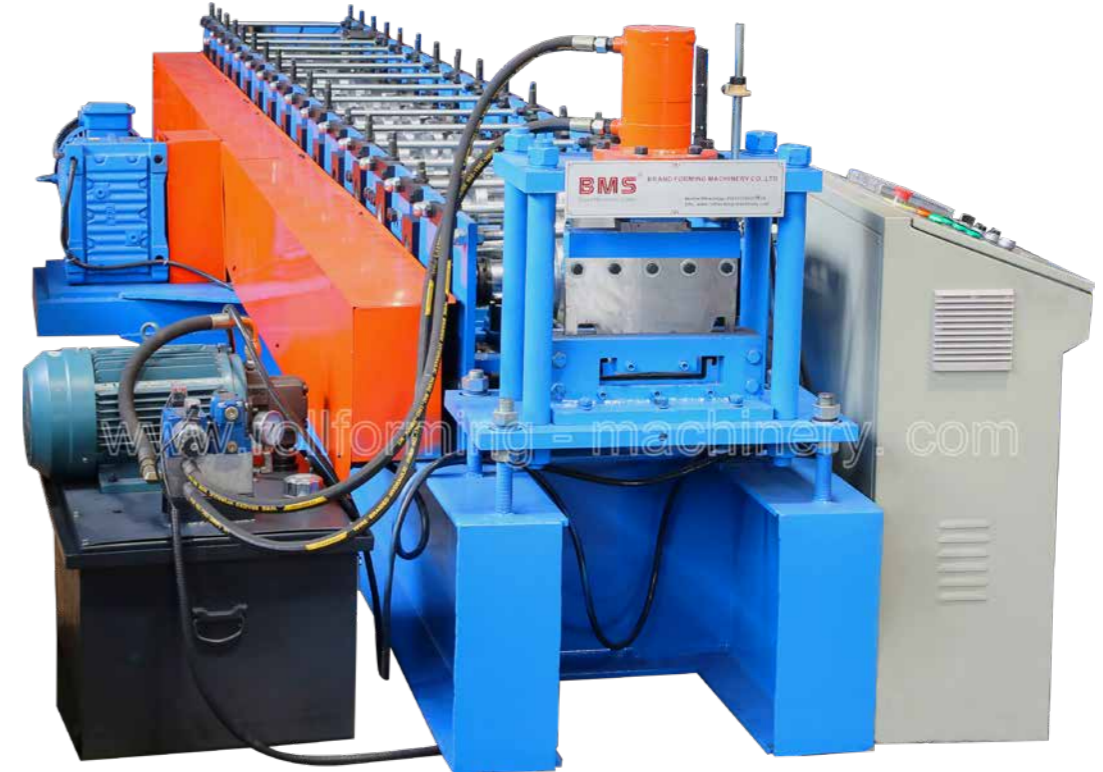

▶▶▶ 版型图
Profile Drawing



样品图
Sample

▶▶▶ 工艺流程图
Producing Process Sketch



设备参数 (MAIN PARAMETERS)

▶ 货架立柱（超市）成型机	▶ Pallet Rack Post Roll Forming Machine-Supermarket series
▶ 辊压厚度：1.2-2.3mm	▶ Thickness：1.2-2.3mm
▶ 验机厚度：1.5mm	▶ Inspection Thickness：1.5mm
▶ 辊压材料：G340-G550镀锌板、冷轧板	▶ Galvanized Steel Coils：G340-G550
▶ 进料宽度：258mm	▶ Feeding Width：258mm

货架承板成型机(电脑自动换型)

Deck Panel Roll Forming Machine(AUTO-Changing type)

YX40-(370-970)货架层板成型机

YX40-(370-970) Shelf layer forming machine

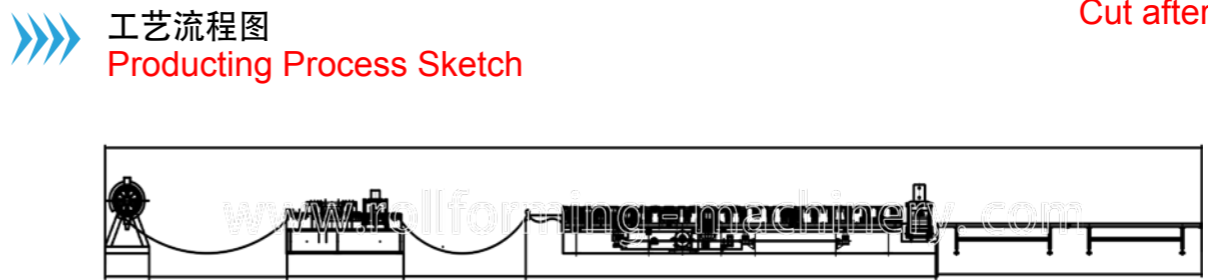
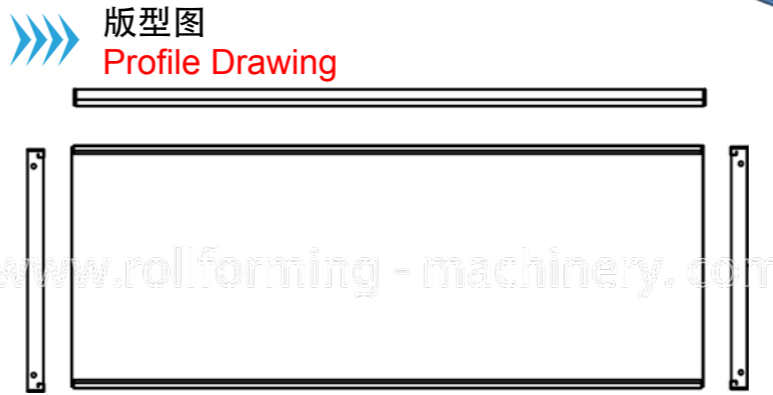
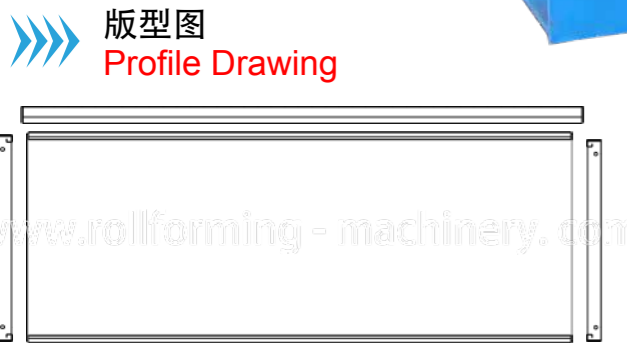
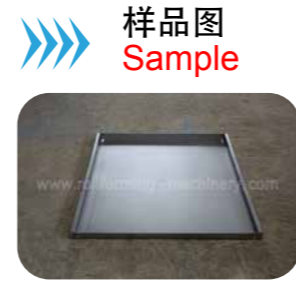
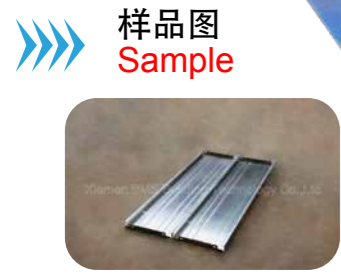
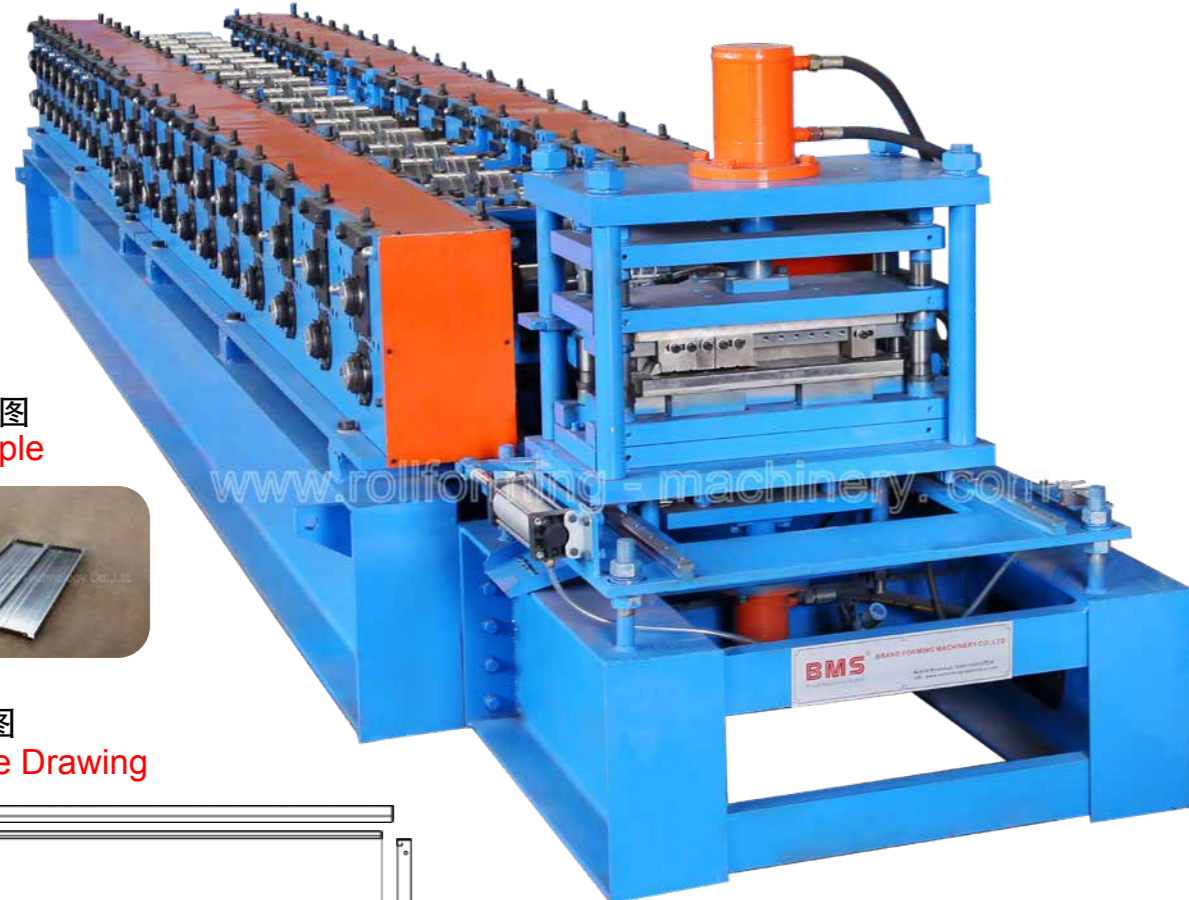

成型后剪
Cut after forming

设备参数 (MAIN PARAMETERS)

▶ 货架承板成型机(电脑自动换型)	▶ DeckPanelRollFormingMachine(Auto-Changing type)
▶ 辊压厚度: 0.6-1.4mm	▶ Thickness: 0.6-1.4mm
▶ 验机厚度: 1.0mm	▶ Inspection Thickness: 1.0mm
▶ 辊压材料: G340-G550镀锌板、冷轧板	▶ Galvanized Steel Coils: G340-G550
▶ 进料宽度: 550-1150	▶ Feeding Width: 550-1150

货架支架成型机

Shelf Bracket Roll Forming Machine



样品图
Sample



进料口
Feeding device

▶▶▶ 版型图
Profile Drawing

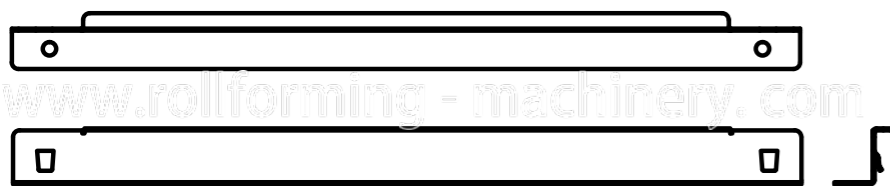

成型后剪
Cut after forming

货架支架成型机

Shelf Bracket Roll Forming Machine



▶▶▶ 样品图
Sample



▶▶▶ 版型图
Profile Drawing

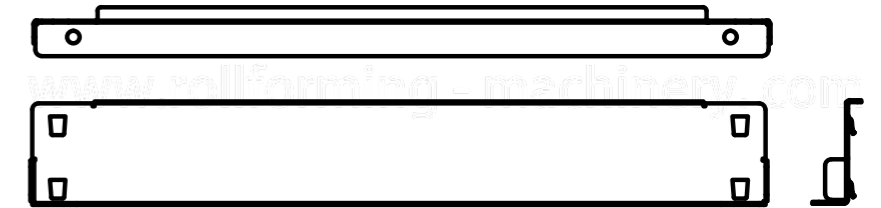

▶▶▶ 工艺流程图
Producing Process Sketch

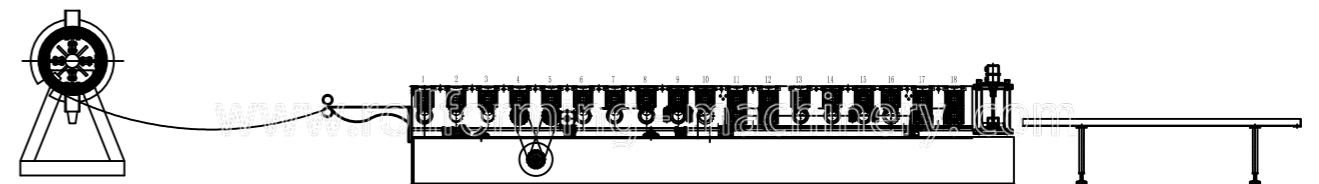

设备参数 (MAIN PARAMETERS)

- | | |
|--------------------------|--------------------------------------|
| ▶ 货架承板成型机(电脑自动换型) | ▶ Shelf Bracket Roll Forming Machine |
| ▶ 辊压厚度: 1.5-2.0mm | ▶ Thickness: 1.5-2.0mm |
| ▶ 验机厚度: 1.5mm | ▶ Inspection Thickness: 1.5mm |
| ▶ 辊压材料: G340-G550镀锌板、冷轧板 | ▶ Galvanized Steel Coils: G340-G550 |
| ▶ 进料宽度: 79mm | ▶ Feeding Width: 79mm |

货架抱梁成型机

Box Beam Roll Forming Machine



样品图
Sample



▶▶▶▶ 版型图
Profile Drawing



成型后剪
Cut after forming

设备参数 (MAIN PARAMETERS)

▶ 货架承板成型机(电脑自动换型)	▶ Box Beam Roll Forming Machine
▶ 辊压厚度: 1.2-1.5mm	▶ Thickness: 1.2-1.5mm
▶ 验机厚度: 1.5mm	▶ Inspection Thickness: 1.5mm
▶ 辊压材料: G340-G550镀锌板、冷轧板	▶ Galvanized Steel Coils: G340-G550
▶ 进料宽度: 220/240/250/260/270mm	▶ Feeding Width: 220/240/250/260/270mm

货架抱梁咬合成型机

Steel Box Beam Seaming Machine



样品图
Sample

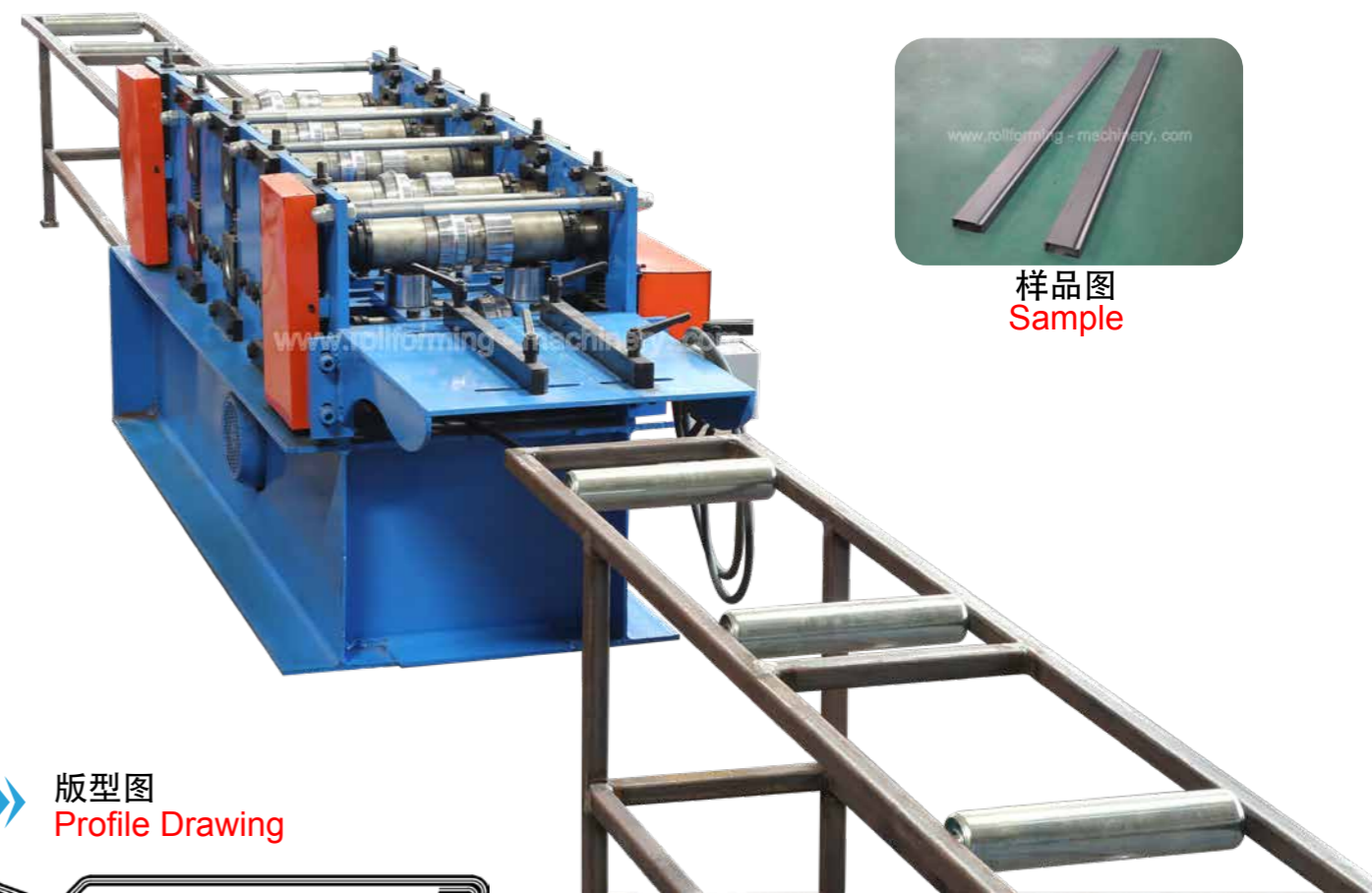

▶▶▶▶ 版型图
Profile Drawing



▶▶▶▶ 工艺流程图
Producing Process Sketch

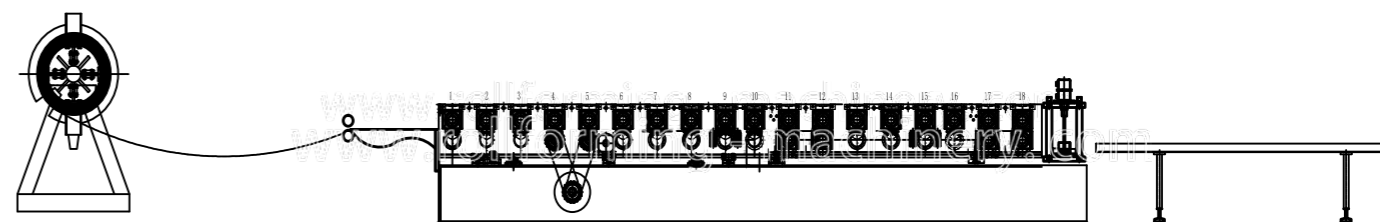

货架支撑龙骨成型机

Shelf Bracket Roll Forming Machine



▶▶▶ 版型图
Profile Drawing



样品图
Sample

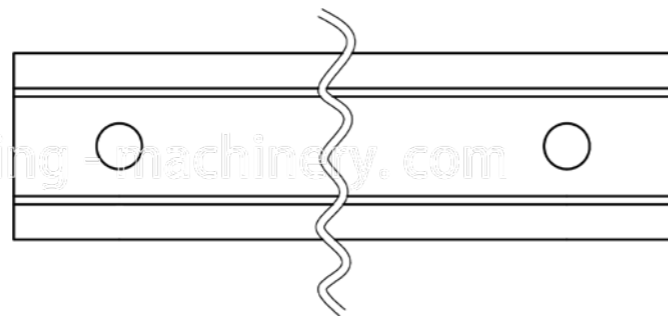

设备参数 (MAIN PARAMETERS)

- | | |
|--------------------------|--------------------------------------|
| ▶ 货架承板成型机(电脑自动换型) | ▶ Shelf Bracket Roll Forming Machine |
| ▶ 辊压厚度: 1.5-2.0mm | ▶ Thickness: 1.5-2.0mm |
| ▶ 验机厚度: 1.5mm | ▶ Inspection Thickness: 1.5mm |
| ▶ 辊压材料: G340-G550镀锌板、冷轧板 | ▶ Galvanized Steel Coils: G340-G550 |
| ▶ 进料宽度: 132mm | ▶ Feeding Width: 132mm |

货架承板加强筋成型机

Omega type Deck Panel(with enhanced ribs) Roll Forming Machine

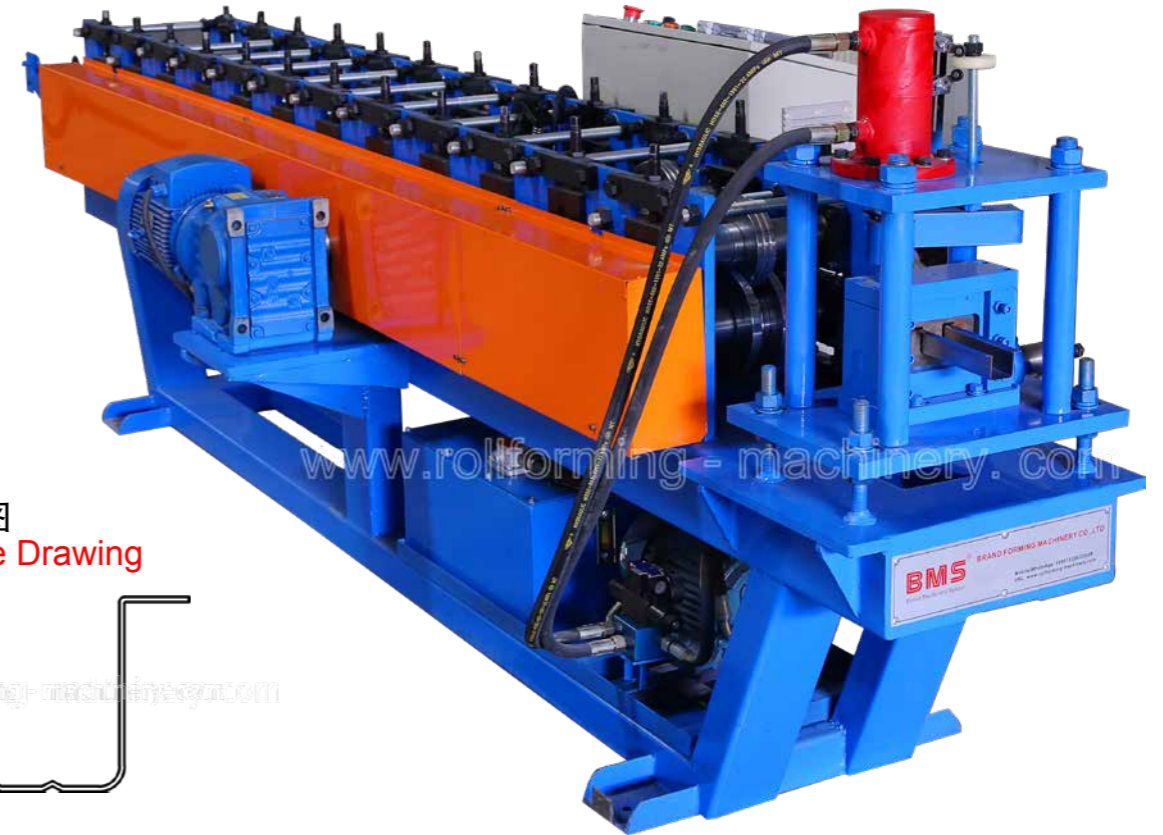

▶▶▶ 版型图
Profile Drawing

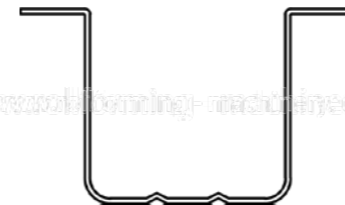

样品图
Sample



样品图
Sample



成型后剪
Cut after forming

▶▶▶ 工艺流程图
Producing Process Sketch

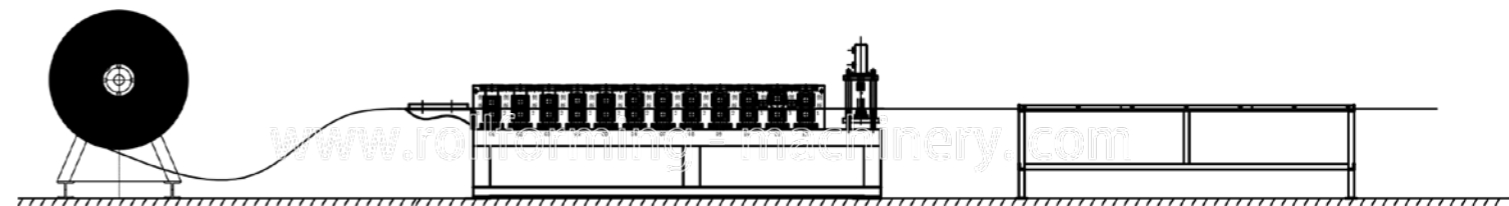

YX11-48轻型横梁货架

YX11-48 light beam shelf



样品图
Sample



▶▶▶▶▶ 版型图
Profile Drawing

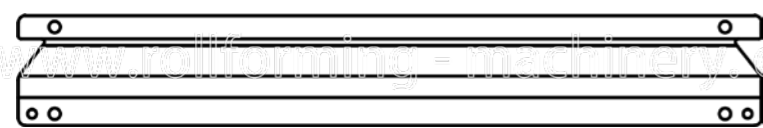

成型后剪
Cut after forming

设备参数 (MAIN PARAMETERS)

▶ YX11-48轻型横梁货架	▶ YX11-48 light beam shelf
▶ 辊压厚度: 0.5-1.0mm	▶ Thickness: 0.5-1.0mm
▶ 验机厚度: 0.8mm	▶ Inspection Thickness: 0.8mm
▶ 辊压材料: G340-G550镀锌板、冷轧板	▶ Galvanized Steel Coils: G340-G550
▶ 进料宽度: 58	▶ Feeding Width: 58

YX35-35轻型立柱货架

YX35-35 light column shelf



成品后剪
Post Cutter



辊轮
Rollers



成型后剪
Cut after forming



▶▶▶▶▶ 版型图
Profile Drawing

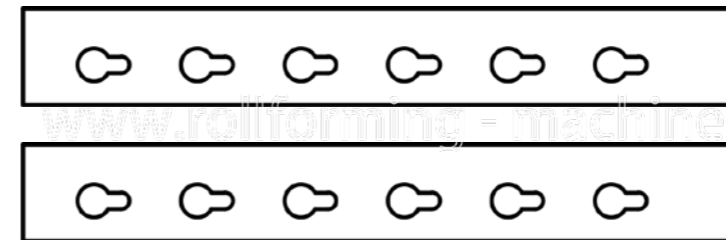

样品图
Sample

▶▶▶▶▶ 工艺流程图
Producing Process Sketch



货架横梁 (P型管) 冷弯成型机

Pallet Rack Step Beam Roll Forming Machine

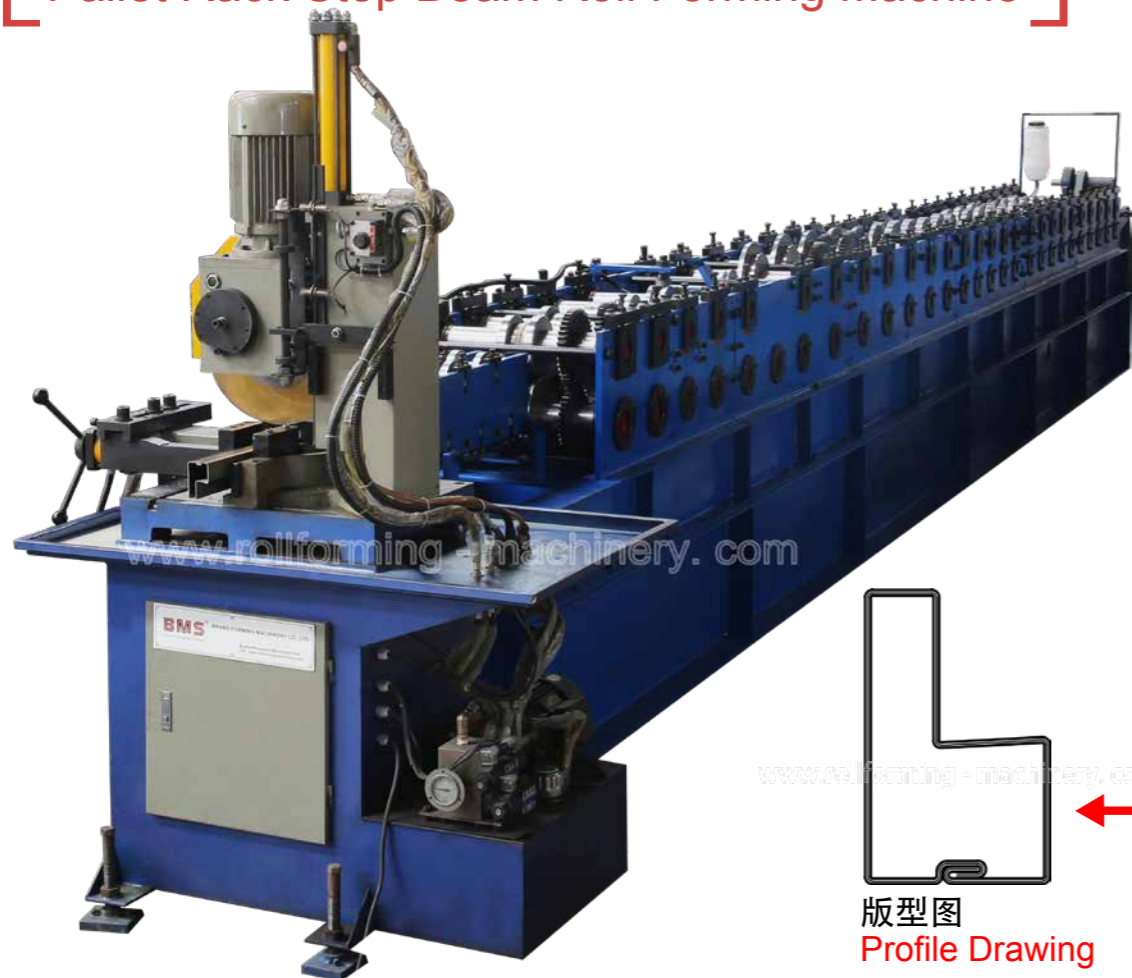

样品图
Sample

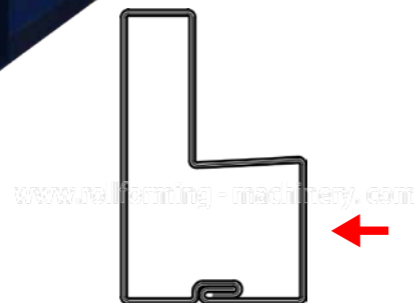

版型图
Profile Drawing



成品后剪
Post Cutter



进料口
Feeding device



辊轮
Rollers

工艺流程图
Producing Process Sketch

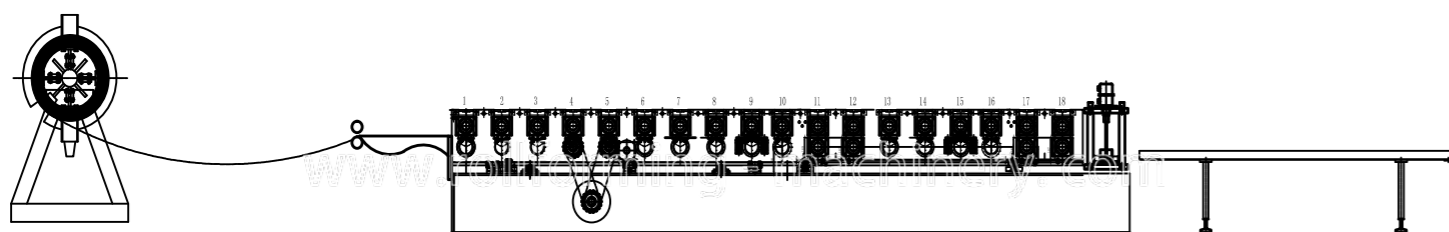

基业箱

Foundation box

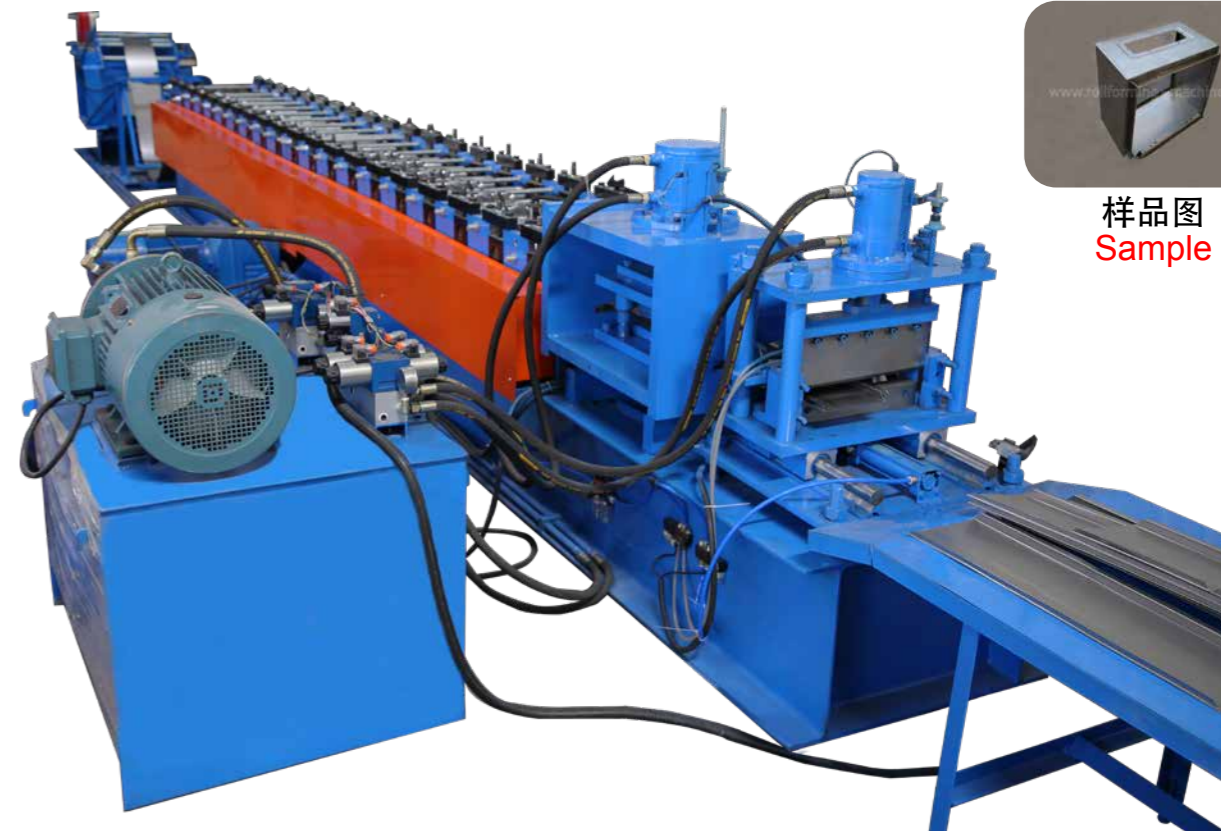

样品图
Sample

版型图
Profile Drawing

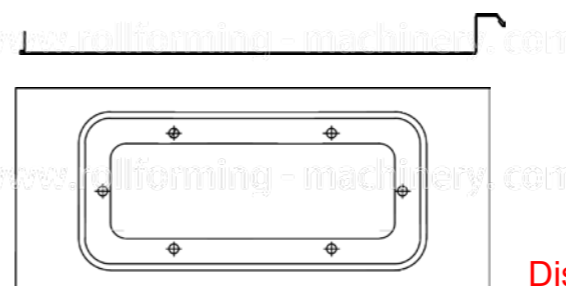

放料伺服一体机
Discharging servo all-in-one machine



冲床
Punching Maxhine

设备参数 (MAIN PARAMETERS)

▶ 基业箱	▶ Foundation box
▶ 辊压厚度: 0.8-1.5mm	▶ Thickness: 0.8-1.5mm
▶ 验机厚度: 0.8mm	▶ Inspection Thickness: 0.8mm
▶ 辊压材料: G340-G550镀锌板、冷轧板	▶ Galvanized Steel Coils: G340-G550
▶ 进料宽度: 192/212/242/262mm	▶ Feeding Width: 192/212/242/262mm

多功能支架

Multifunctional bracket



样品图
Sample



版型图
Profile Drawing

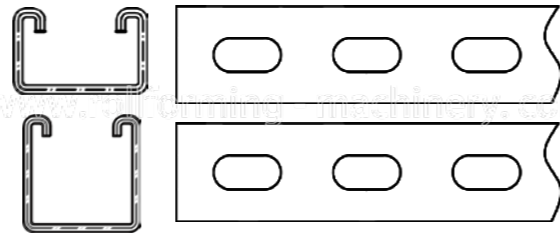

光伏支架

Photovoltaic bracket



样品图
Sample

版型图
Profile Drawing

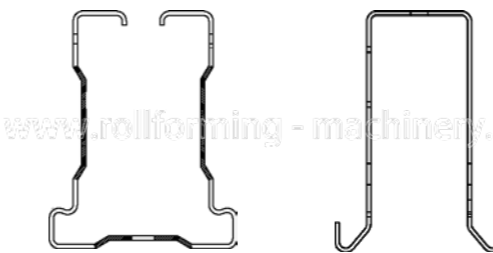

成型后剪
Cut after forming



辊轮
Rollers

工艺流程图
Producing Process Sketch

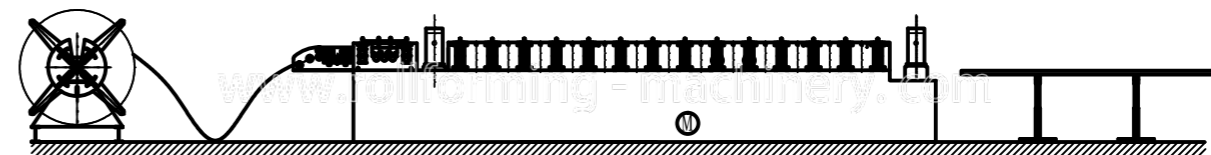

成型前剪
Cut before forming



冲床
Punching Maxhine



进料口
Feeding device

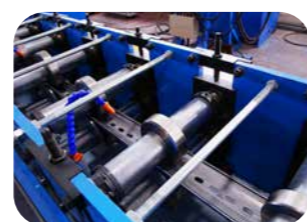

辊轮
Rollers

设备参数 (MAIN PARAMETERS)

▶ 多功能支架	▶ Multifunctional bracket
▶ 辊压厚度: 1.5-2.5mm	▶ Thickness: 1.5-2.5mm
▶ 验机厚度: 1.5mm	▶ Inspection Thickness: 1.5mm
▶ 辊压材料: G235-G390镀锌板、冷轧板	▶ Galvanized Steel Coils: G235-G390
▶ 进料宽度: 135mm	▶ Feeding Width: 135mm

货架附件冲压成型一体机

Load Beam Bracket Punching and Forming Machine



进料口
Feeding device



放料伺服一体机
Discharging servo all-in-one machine

样品图
Sample



版型图
Profile Drawing

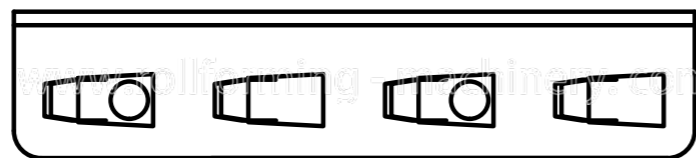
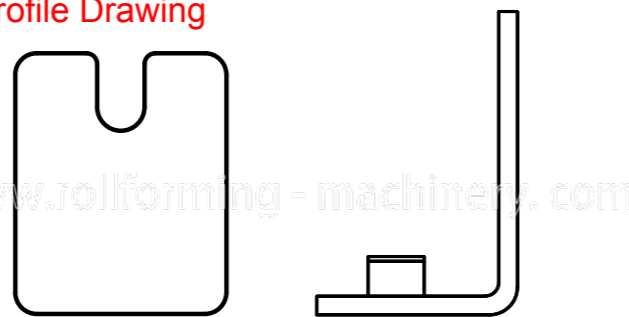

高速放料-冲孔-收料一体机

Decoiler Punching And Recoiler Line



细节图
Detail drawing



PLC 控制柜
PLC Control Cabinet



进料口
Feeding device



放料伺服一体机
Discharging servo all-in-one machine

工艺流程图
Producing Process Sketch

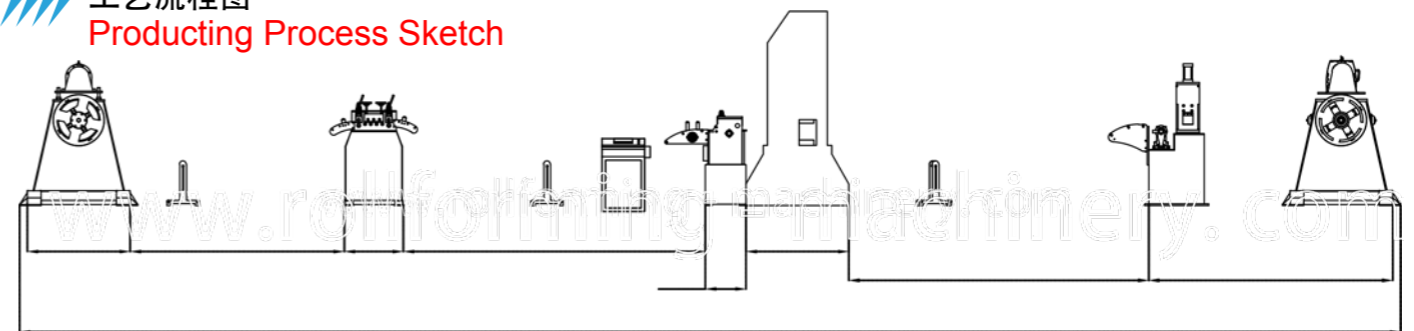

重型货架 Heavy Duty Racking System

轻型货架 Light Duty Racking System



样品图
Sample



样品图
Sample



成品图
Profile Samples



成品图
Profile Samples



横梁与立柱的连接方式

型材示意:

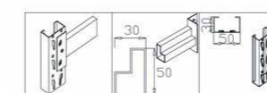

货架立柱版型图 Pallet Rack Post Profiles

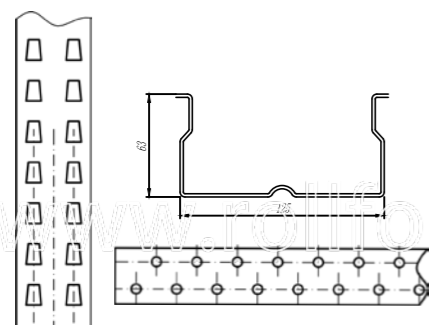

辊压厚度: 2.0-2.5mm
Rolling thickness: 2.0-2.5mm
辊压材料: G340-G550镀锌板、冷轧板
Rolling material: G340-G550 galvanized sheet, cold rolled sheet

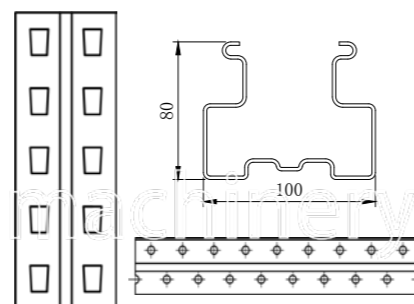

辊压厚度: 2.0-3.0mm
Rolling thickness: 2.0-3.0mm
辊压材料: G340-G550镀锌板、冷轧板
Rolling material: G340-G550 galvanized sheet, cold rolled sheet

货架立柱版型图 Pallet Rack Post Profiles

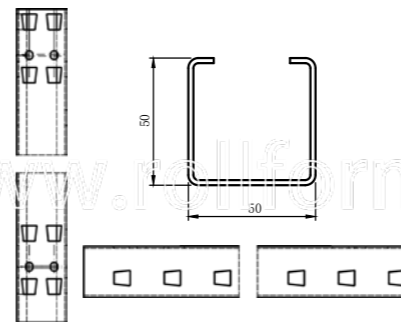

辊压厚度: 1.4-2.0mm
Rolling thickness: 1.4-2.0mm
辊压材料: G340-G550镀锌板、冷轧板
Rolling material: G340-G550 galvanized sheet, cold rolled sheet

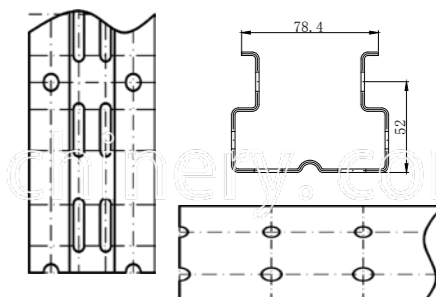

辊压厚度: 2.0-3.0mm
Rolling thickness: 2.0-3.0mm
辊压材料: G340-G550镀锌板、冷轧板
Rolling material: G340-G550 galvanized sheet, cold rolled sheet

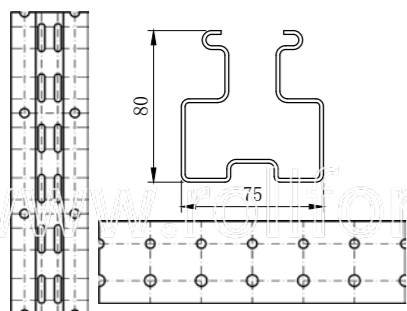

辊压厚度: 2.0-3.0mm
Rolling thickness: 2.0-3.0mm
辊压材料: G340-G550镀锌板、冷轧板
Rolling material: G340-G550 galvanized sheet, cold rolled sheet

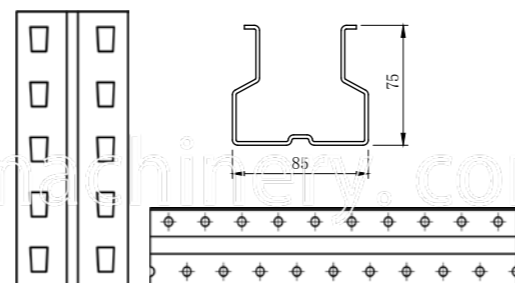

辊压厚度: 2.0-3.0mm
Rolling thickness: 2.0-3.0mm
辊压材料: G340-G550镀锌板、冷轧板
Rolling material: G340-G550 galvanized sheet, cold rolled sheet



样品图
Sample



样品图
Sample

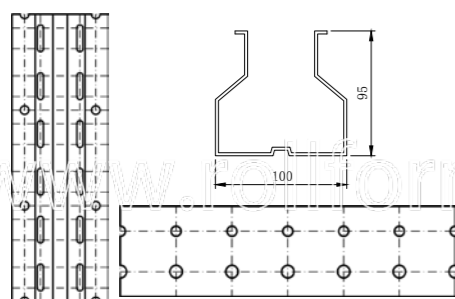

辊压厚度: 2.0-3.0mm
Rolling thickness: 2.0-3.0mm
辊压材料: G340-G550镀锌板、冷轧板
Rolling material: G340-G550 galvanized sheet, cold rolled sheet

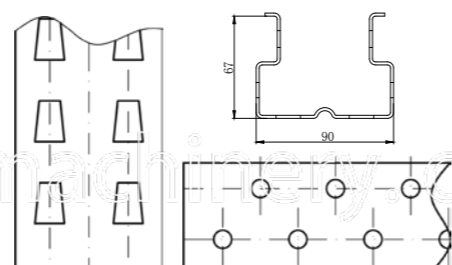

辊压厚度: 1.4-2.0mm
Rolling thickness: 1.4-2.0mm
辊压材料: G340-G550镀锌板、冷轧板
Rolling material: G340-G550 galvanized sheet, cold rolled sheet



样品图
Sample



样品图
Sample

货架横梁版型图
Shelf Load Beam Profiles

货架横梁版型图
Shelf Load Beam Profiles

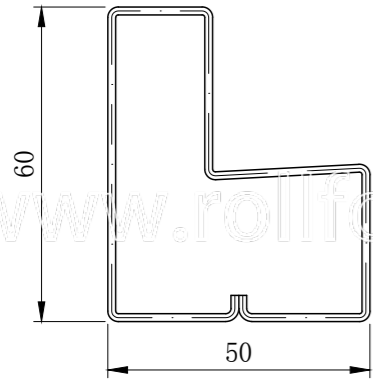

辊压厚度: 1.5-2.0mm
Rolling thickness: 1.5-2.0mm
辊压材料: G340-G550镀锌板、冷轧板
Rolling material: G340-G550 galvanized sheet, cold rolled sheet

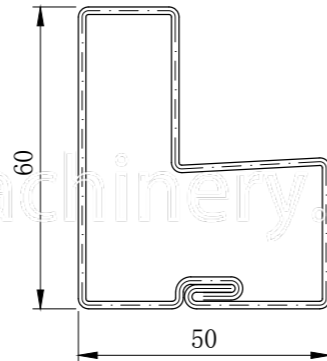

辊压厚度: 1.2-1.5mm
Rolling thickness: 1.2-1.5mm
辊压材料: G340-G550镀锌板、冷轧板
Rolling material: G340-G550 galvanized sheet, cold rolled sheet



辊压厚度: 1.5-2.0mm
Rolling thickness: 1.5-2.0mm
辊压材料: G340-G550镀锌板、冷轧板
Rolling material: G340-G550 galvanized sheet, cold rolled sheet

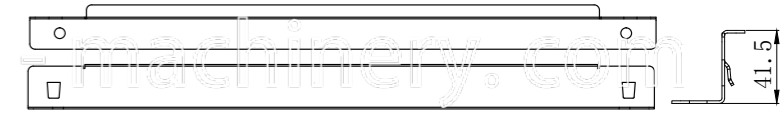

辊压厚度: 1.5-2.0mm
Rolling thickness: 1.5-2.0mm
辊压材料: G340-G550镀锌板、冷轧板
Rolling material: G340-G550 galvanized sheet, cold rolled sheet

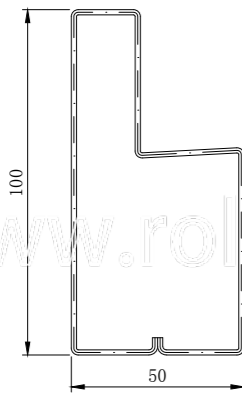

辊压厚度: 1.5-2.0mm
Rolling thickness: 1.5-2.0mm
辊压材料: G340-G550镀锌板、冷轧板
Rolling material: G340-G550 galvanized sheet, cold rolled sheet

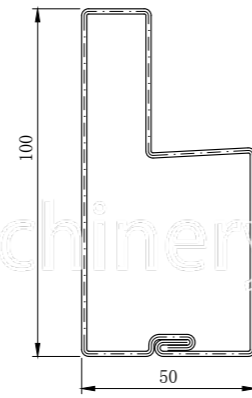

辊压厚度: 1.2-1.5mm
Rolling thickness: 1.2-1.5mm
辊压材料: G340-G550镀锌板、冷轧板
Rolling material: G340-G550 galvanized sheet, cold rolled sheet

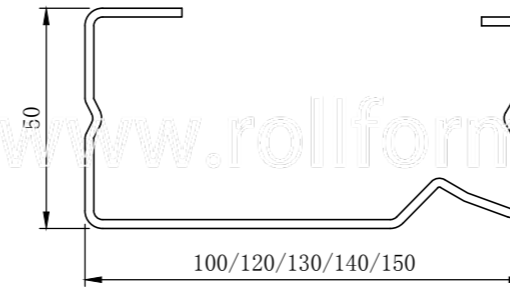

辊压厚度: 1.5-2.0mm
Rolling thickness: 1.5-2.0mm
辊压材料: G340-G550镀锌板、冷轧板
Rolling material: G340-G550 galvanized sheet, cold rolled sheet

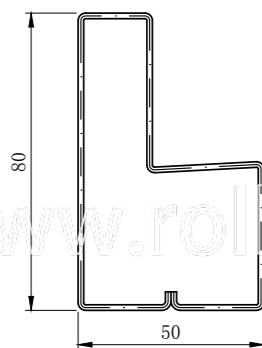

辊压厚度: 1.5-2.0mm
Rolling thickness: 1.5-2.0mm
辊压材料: G340-G550镀锌板、冷轧板
Rolling material: G340-G550 galvanized sheet, cold rolled sheet

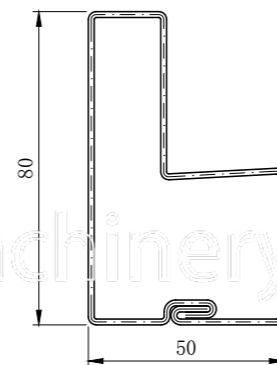

辊压厚度: 1.2-1.5mm
Rolling thickness: 1.2-1.5mm
辊压材料: G340-G550镀锌板、冷轧板
Rolling material: G340-G550 galvanized sheet, cold rolled sheet

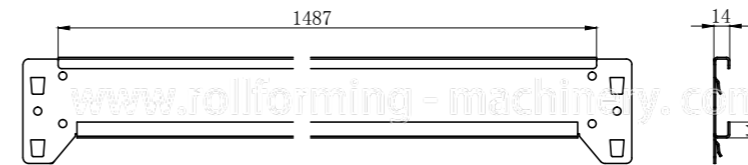

辊压厚度: 1.5mm
Rolling thickness: 1.5mm
辊压材料: G340-G550镀锌板、冷轧板
Rolling material: G340-G550 galvanized sheet, cold rolled sheet



样品图
Sample

货架横梁版型图

Shelf Load Beam Profiles

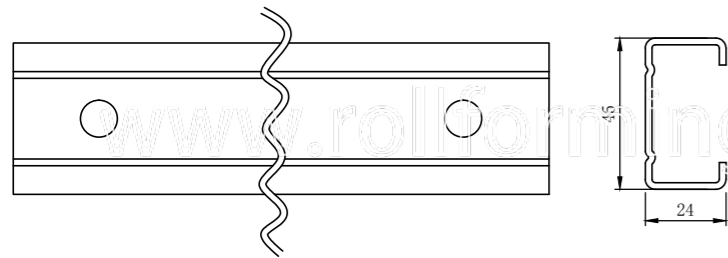

C24-45斜撑板
C24-45 inclined stay plate
辊压厚度: 1.5-2.0mm
Rolling thickness: 1.5-2.0mm
辊压材料: G340-G550镀锌板、冷轧板
Rolling material: G340-G550 galvanized sheet, cold rolled sheet



YX40-(350-1000)货架承板
YX40- (350-1000) shelf support plate
辊压厚度: 0.6-1.4mm
Rolling thickness: 0.6-1.4mm
辊压材料: G340-G550镀锌板、冷轧板
Rolling material: G340-G550 galvanized sheet, cold rolled sheet

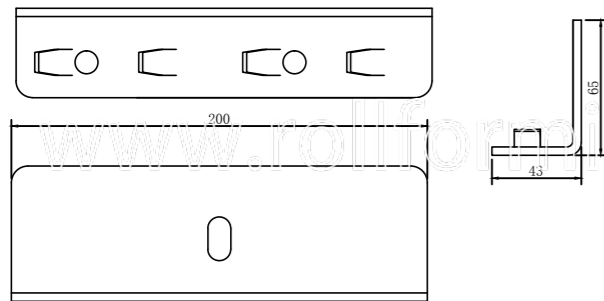

YX65-43角铁
YX65-43 angle iron
辊压厚度: 3.2-4.0mm
Rolling thickness: 3.2-4.0mm
辊压材料: G340-G550镀锌板、冷轧板
Rolling material: G340-G550 galvanized sheet, cold rolled sheet

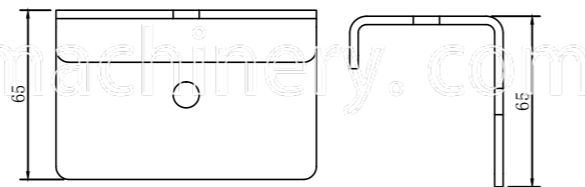

YX65-58.4U型冲压件
YX65-58.4U stamping parts
辊压厚度: 3.2mm
Rolling thickness: 3.2mm
辊压材料: G340-G550镀锌板、冷轧板
Rolling material: G340-G550 galvanized sheet, cold rolled sheet

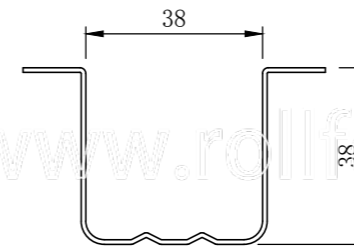

YX38-38帽型龙骨
YX38-38 hat keel
辊压厚度: 0.6-1.2mm
Rolling thickness: 0.6-1.2mm
辊压材料: G340-G550镀锌板、冷轧板
Rolling material: G340-G550 galvanized sheet, cold rolled sheet

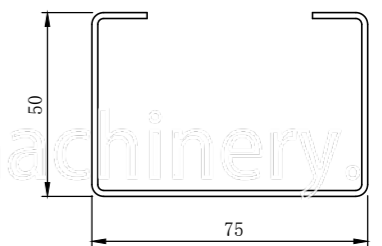

单C机
Single C machine
辊压厚度: 1.5-2.0mm
Rolling thickness: 1.5-2.0mm
辊压材料: G340-G550镀锌板、冷轧板
Rolling material: G340-G550 galvanized sheet, cold rolled sheet

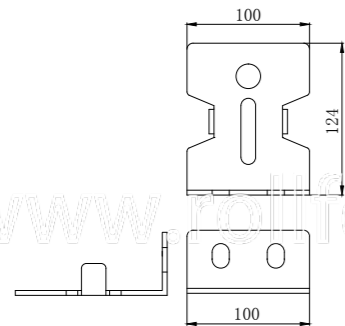

冲压件2
Stamping 2
辊压厚度: 3.2-4.0mm
Rolling thickness: 3.2-4.0mm
辊压材料: G340-G550镀锌板、冷轧板
Rolling material: G340-G550 galvanized sheet, cold rolled sheet

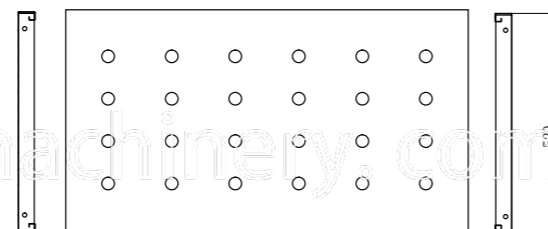

货架承板520宽冲孔
Shelf support 520 wide punching
辊压厚度: 1.0mm
Rolling thickness: 1.0mm
辊压材料: G340-G550镀锌板、冷轧板
Rolling material: G340-G550 galvanized sheet, cold rolled sheet

货架版型图

Shelving and Racking Profiles

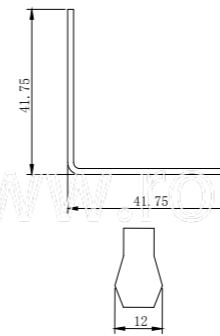

L 35*35角铁成型机
L Angle Roll Forming Machine
辊压厚度: 1.4-1.5mm
Rolling thickness: 1.4mm
辊压材料: G235镀锌板、冷轧板
Rolling material: G235 galvanized sheet, cold rolled sheet

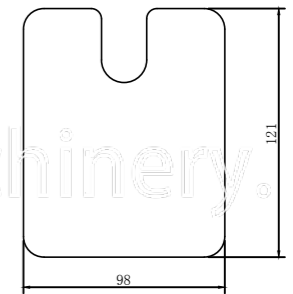

冲压件1
Stamping 1
辊压厚度: 3.2-4.0mm
Rolling thickness: 3.2-4.0mm
辊压材料: G340-G550镀锌板、冷轧板
Rolling material: G340-G550 galvanized sheet, cold rolled sheet



样品图
Sample



样品图
Sample

