

[단면보기]
Profile Drawing

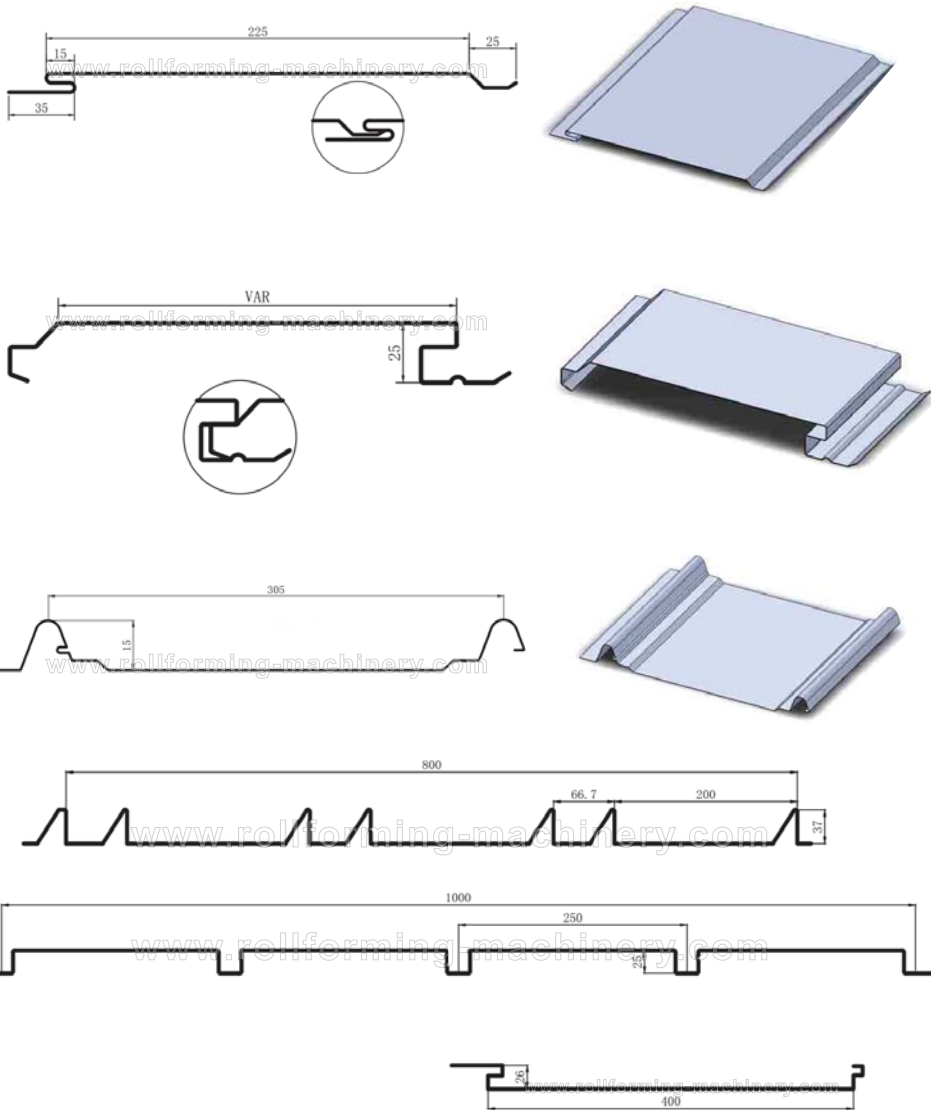

[단면보기]
Profile Drawing

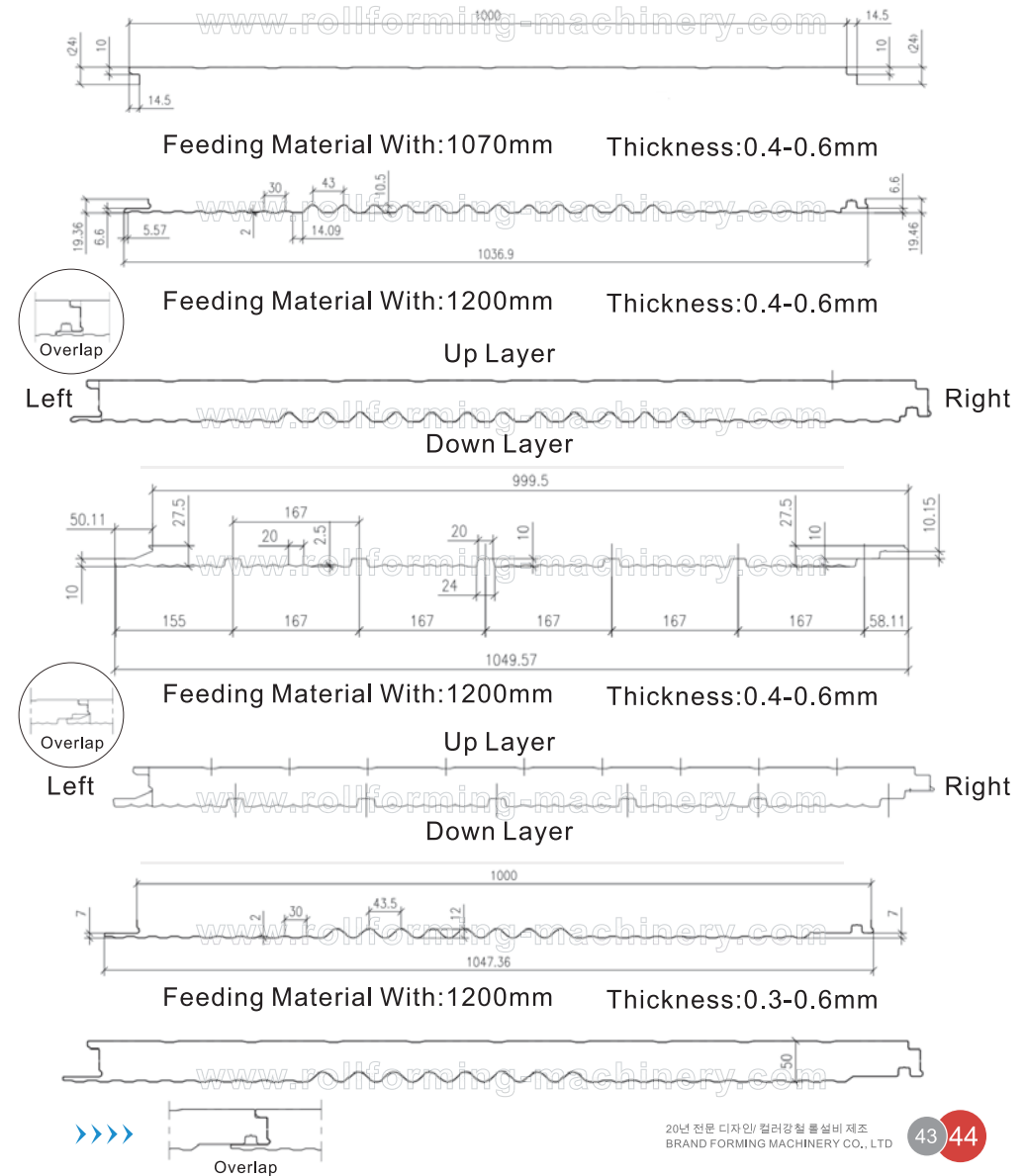

[단면보기]
Profile Drawing

Polyurethane Panel _ 폴리우레탄판넬

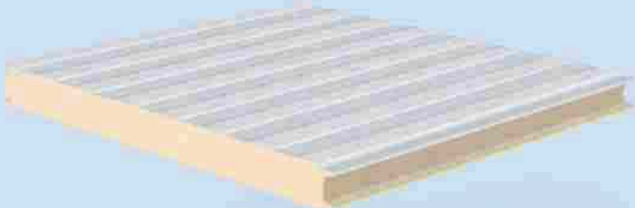
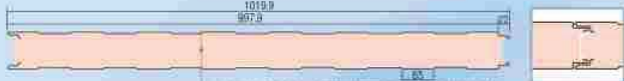

벽체 판넬
Wall panel

내부단열재
PUF / PFR (내연 3급) 경질우레탄폼
Core material
Polyurethane Foam (PUF)
Polycarbonate Foam (PFR)

내차 표면재 : 0.45 ~ 0.6mm 도장용 알루미늄 코팅판 (도장재 : 폴리에스터 또는 폴스)
Skin material : 0.45 ~ 0.6mm For coated Aluminum Sheet (Paint : Polyurethane or PVC)
내부단열재 : PUF / PFR (내연 3급) 경질우레탄폼
Core material : Polyurethane Foam (PUF), Polycarbonate Foam (PFR)
두께 (mm) : 50, 75, 100, 125, 150
Thickness : 0.5, 0.75, 1.0, 1.25, 1.5

볼트레스 250골
Boltsless 250 corrugations panel





내부단열재
PUF / PFR (내연 3급) 경질우레탄폼
Core material
Polyurethane Foam (PUF)
Polycarbonate Foam (PFR)

내차 표면재 : 0.45 ~ 0.6mm 도장용 알루미늄 코팅판 (도장재 : 폴리에스터 또는 폴스)
Skin material : 0.45 ~ 0.6mm For coated Aluminum Sheet (Paint : Polyurethane or PVC)
내부단열재 : PUF / PFR (내연 3급) 경질우레탄폼
Core material : Polyurethane Foam (PUF), Polycarbonate Foam (PFR)
두께 (mm) : 50, 75, 100
Thickness : 0.5, 0.75, 1.0

[단면보기]
Profile Drawing

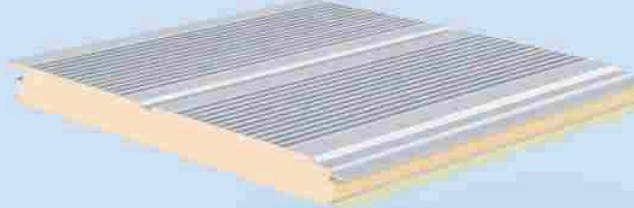

볼트레스 500골
Boltsless 500 corrugations panel

내부단열재
PUF / PFR (내연 3급) 경질우레탄폼
Core material
Polyurethane Foam (PUF)
Polycarbonate Foam (PFR)

내차 표면재 : 0.45 ~ 0.6mm 도장용 알루미늄 코팅판 (도장재 : 폴리에스터 또는 폴스)
Skin material : 0.45 ~ 0.6mm For coated Aluminum Sheet (Paint : Polyurethane or PVC)
내부단열재 : PUF / PFR (내연 3급) 경질우레탄폼
Core material : Polyurethane Foam (PUF), Polycarbonate Foam (PFR)
두께 (mm) : 50, 75, 100
Thickness : 0.5, 0.75, 1.0

볼트레스 1000골
Boltsless 1000 corrugations panel

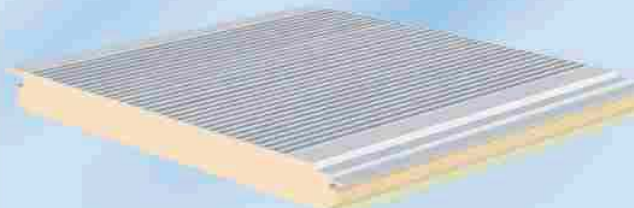
내부단열재
PUF / PFR (내연 3급) 경질우레탄폼
Core material
Polyurethane Foam (PUF)
Polycarbonate Foam (PFR)

내차 표면재 : 0.45 ~ 0.6mm 도장용 알루미늄 코팅판 (도장재 : 폴리에스터 또는 폴스)
Skin material : 0.45 ~ 0.6mm For coated Aluminum Sheet (Paint : Polyurethane or PVC)
내부단열재 : PUF / PFR (내연 3급) 경질우레탄폼
Core material : Polyurethane Foam (PUF), Polycarbonate Foam (PFR)
두께 (mm) : 50, 75, 100
Thickness : 0.5, 0.75, 1.0

[단면보기]
Profile Drawing

Polyurethane Panel _ 폴리우레탄판넬

볼트레스 250골
Boltless 250 corrugations panel

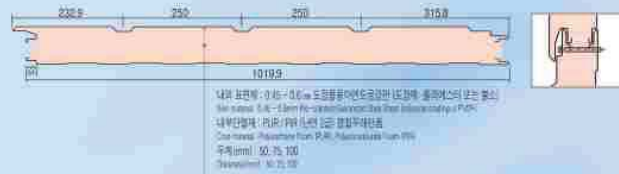

내부단열재
PUR / PU (LSD) 2종 경질우레탄폼
Core material
Polyurethane Foam (PUR)
Polycarbonate Foam (PC)

볼트레스 500골
Boltless 500 corrugations panel



내부단열재
PUR / PU (LSD) 2종 경질우레탄폼
Core material
Polyurethane Foam (PUR)
Polycarbonate Foam (PC)

[단면보기]
Profile Drawing

볼트레스 1000골
Boltless 1000 corrugations panel

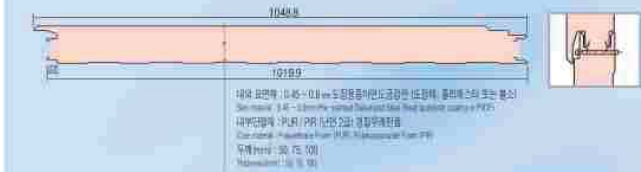

내부단열재
PUR / PU (LSD) 2종 경질우레탄폼
Core material
Polyurethane Foam (PUR)
Polycarbonate Foam (PC)

지붕용
Roof panel

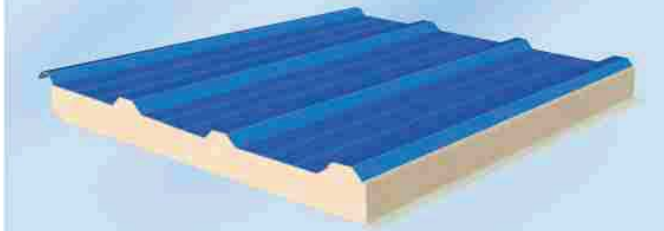

내부단열재
PUR / PU (LSD) 2종 경질우레탄폼
Core material
Polyurethane Foam (PUR)
Polycarbonate Foam (PC)